



The Heart of Industry

IWAKI

IWAKI
MAGNETIC
DRIVE
PUMPS

MDE



Solutions for chemical handling applications

The world's largest-class non-metallic magnetic drive pumps for chemical processing

The MDE Series comprises the world's largest-class non-metallic magnetic drive pumps for chemical processing, with a maximum delivery of 4.0m³/min. and a maximum head of over 50 meters. The liquid end parts, plastics are made of advanced corrosion-resistant materials such as fluororesins and fine ceramics, and the major fluoroplastic-made parts are reinforced with special metal inserts for added mechanical strength and durability. These pumps have a maximum casing-pressure resistance of 1.6 MPa and a maximum operating temperature of 100°C.

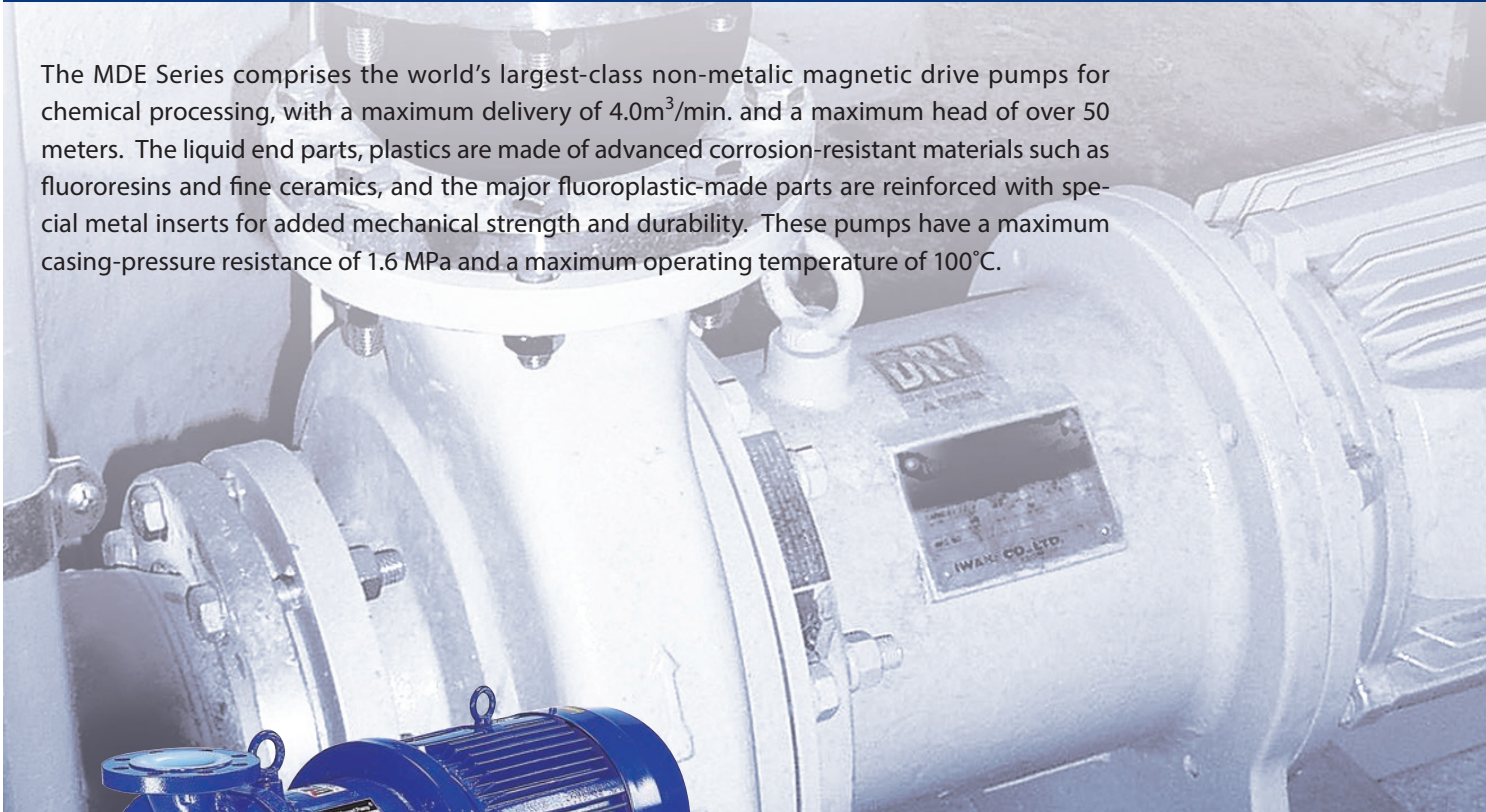

MDE65

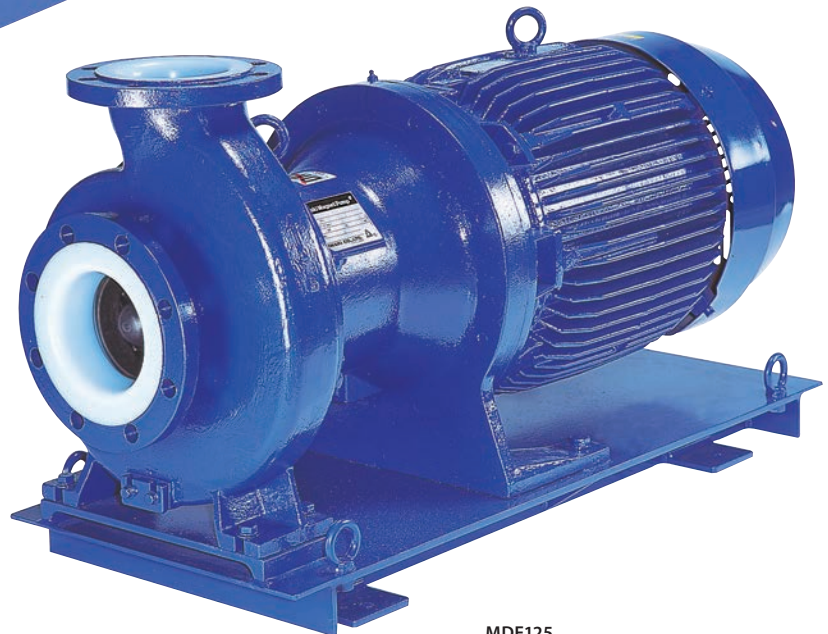

MDE125



Strong Corrosion Resistance

Fluoroplastic and fine ceramic are used in the liquid end parts. These materials enable strong acids, strong alkalines, and virtually all chemical solutions to be handled.

High Levels of Durability

The exterior of the pumps is covered with ductile cast iron (FCD400). Ample pressure resistance has been provided in the rear casing through the adoption of a unique shape that prevents the concentration of stress, and a dual structure reinforced with an FRP cover. In addition, the spindle and magnet capsule, which are subject to the repetitive stress of rotational vibration, are made of fluoro-resin with special metal inserts. These

are thus built to withstand sustained operation over an extended period under harsh service conditions.

Compliant with standards ISO

The basic performance, dimensions, and other particulars of the pumps are in compliance with the international standard (ISO2858, 3661, 5199).

They are interchangeable with general-purpose centrifugal pumps.

Note: Model MDE 125-250 is excluded.

Back pullout construction

The pumps have back pullout construction, enabling their internals to be inspected or their component parts to be replaced without disconnecting associated piping. Moreover, the simplified construction consisting of unit components makes maintenance and inspection easy.

Examples of applications

• CHEMICALS

Soda industry (manufacture of hydrochloric and hypochlorous acids, as well as their secondary products), manufacture of hydrofluoric acids and fluorides, manufacture of chemical fertilizers, circulation of reaction liquid in gas-absorption towers, oil refining (sulfuric acid), use in waste-acid recovery and regeneration facilities, and transfer and supply of strong acids to tank trucks at general chemical plants

• PHARMACEUTICALS

Manufacture of high purity chemicals for semiconductors, manufacture of agricultural chemicals, use in factories for the synthesis of medicine, and manufacture of chemicals for water treatment

• PLATING

Recycle filtration of plating liquid for various plating systems

• ELECTRICAL APPLIANCES

Manufacture of electrolytic capacitors (etching of aluminum film), hydrofluoric-acid treatment of braun tubes, transfer of electrolytic liquid for storage batteries and dry cells, etching of printed wiring boards, and transfer of pure chemicals for semiconductors

• METAL INDUSTRY

Use in alumite treatment facilities, degreasing and pickling at wire elongation plants and steel-rolling mills, use in facilities for the prepainting treatment of vehicles (degreasing and acid washing), and use in factories for the manufacture of titanium oxide, rare-earth elements, etc.

• MINING

Metal smelting (transfer and circulation of electrolytic liquid) and scrubber treatment of waste gases

• FOOD INDUSTRY

Manufacture of monosodium glutamate (hydrochloric acid), refining of edible oils (sulfuric acid), and use in fruit-canning plants (hydrochloric acid)

• WATER TREATMENT

Washing of ion-exchange resins, and use in pure-water production facilities and salt-to-fresh brine distillation facilities

• POLLUTION CONTROL

Charging of wastewater treatment chemicals into injection tanks, collection and transfer of waste liquid, and use in gas adsorption facilities (deodorization equipment, desulfurization of flue gas, etc.)

Construction and materials

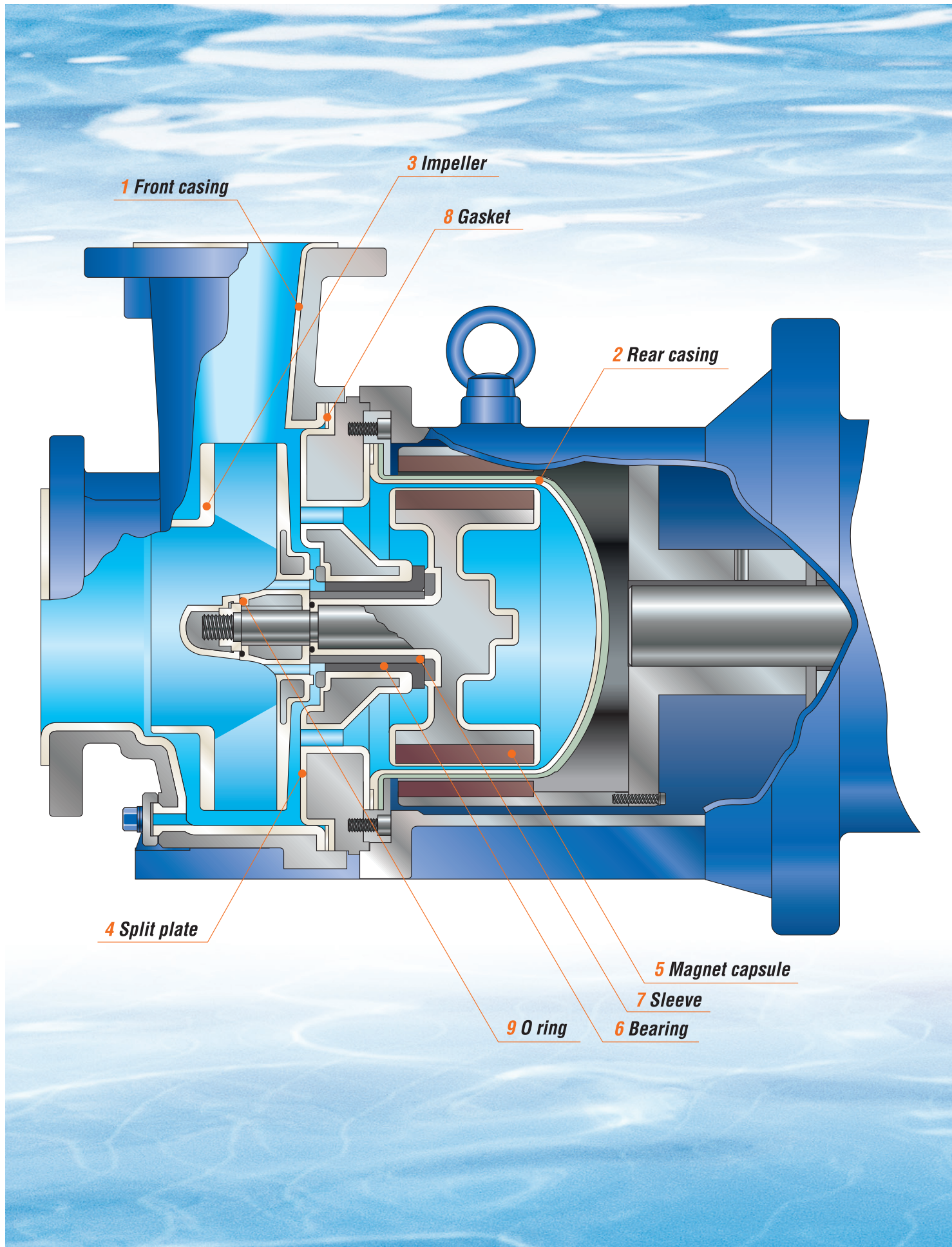

2 Rear casing

The base of this component has a unique downed shape that prevents stress concentration. In addition, this component is reinforced with an FRP cover to provide the required pressure resistance. It is also designed to maximise safety by preventing sparks from being discharged if it is accidentally contacted by the drive magnet.



Mechanical strength and pumping efficiency have been improved over previous types.

4 Split plate

This is made of fluoro-resin with a mold-in ductile cast steel insert. Its sturdy construction supports the rotor assembly rigidly. Moreover, it has a back-flow port that is effective in cooling the bearing parts and discharging slurry (PAT.No.2116798).

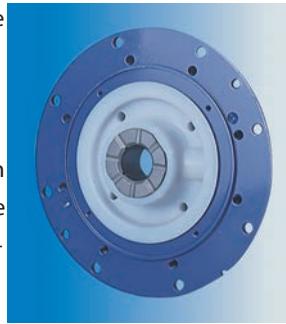

5 Magnet capsule

The metal shaft and rare-earth magnet have a hermetically molded fluoroplastic cover. It has excellent durability and produces high torque.

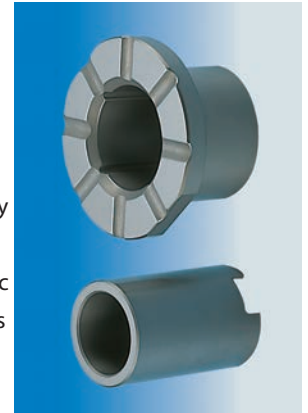

3 Impeller

The impeller with integral shroud has a molded-in metal reinforcing insert.

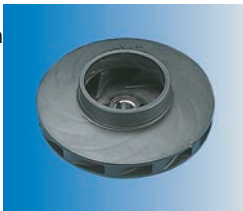

6 Bearing / 7 Sleeve

The use of SiC for these parts maximises their abrasion resistance, impact resistance, and heat resistance. The sleeve system has been adopted to ease maintenance and replacement and reduce costs.

Liquid end materials

Part number	Part name	Material
1	Front casing	ETFE
2	Rear casing	PFA
3	Impeller	CFRETFE
4	Split plate	PFA
5	Magnet capsule	
6	Bearing	SiC
7	Sleeve	
8	Gasket	PTFE
9	O-Ring ^{Note}	Kalrez [®]

Note: FKM/EPDM are also available on request.

Modular construction

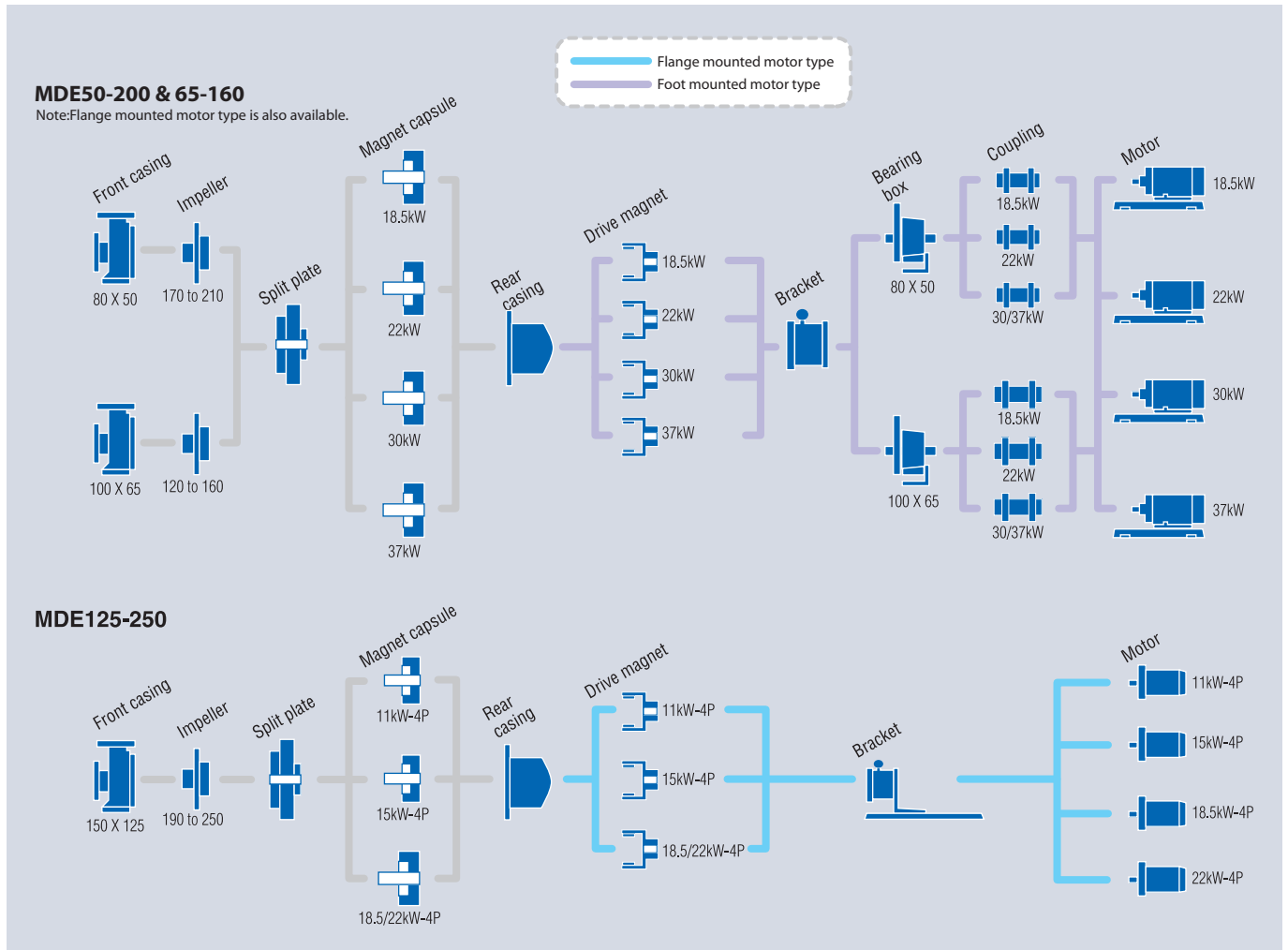

Specification

Models	Nominal bore size Inlet X Outlet	Duty point (50Hz)		
		Capacity l/min	Head m	Pressure limit bar
MDE50-200	80mm X 50mm	833	53.0	16
MDE65-160	100mm X 65mm	1670	38.0	16
MDE125-250	150mm X 125mm	2400	22.5	10

Common specifications

Temperature range of liquid handled: 0 to 100°C
 Allowable slurry: For this information, please contact us.

Pump identification

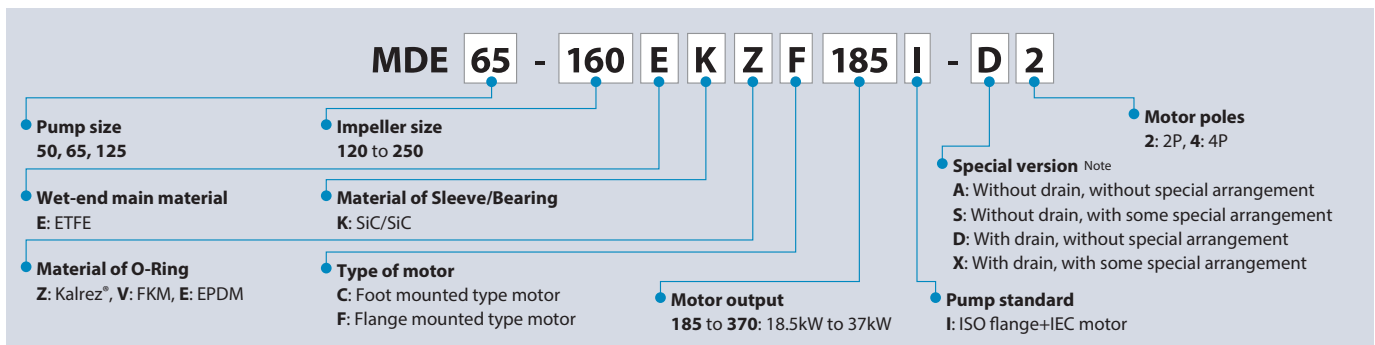

Note: Other options are also available. For detail, please contact us.

Performance curves

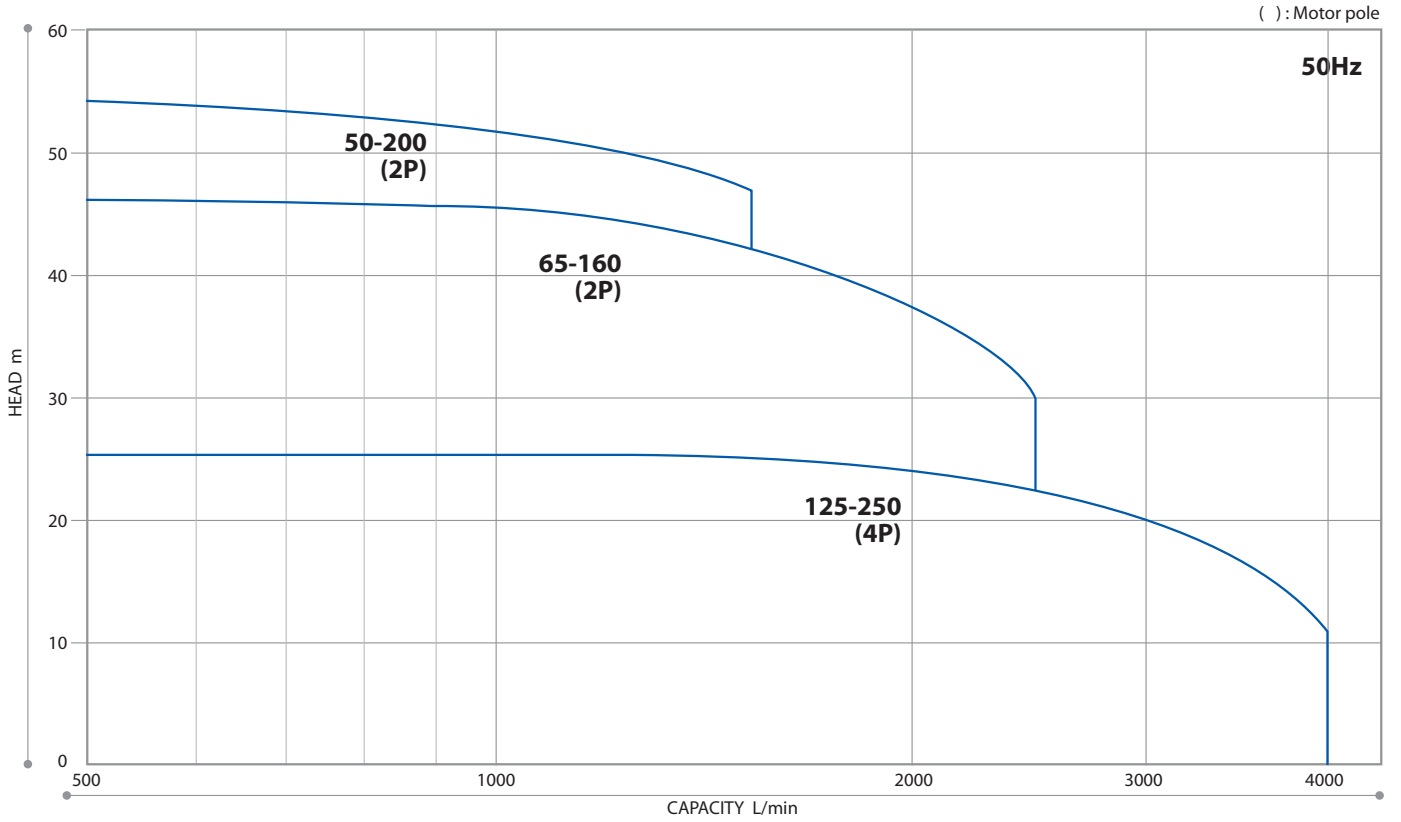

Dimensions in mm

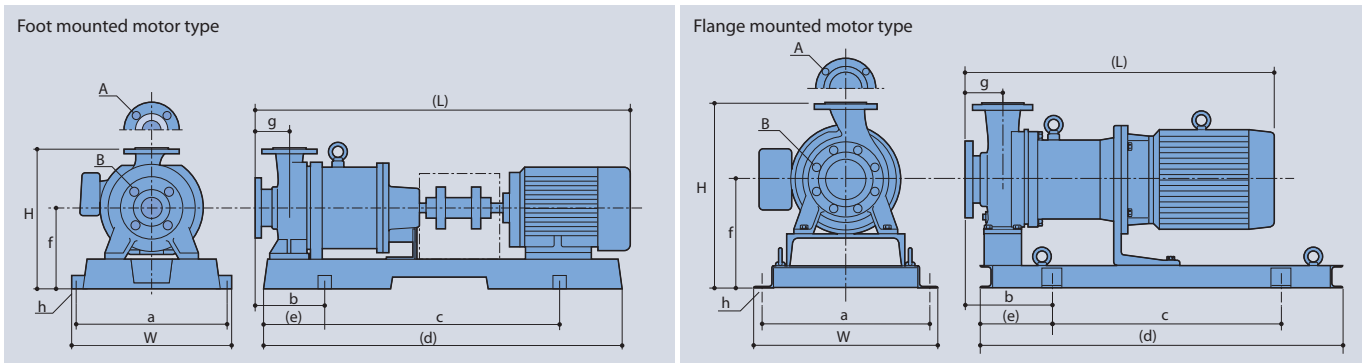

Foot mounted motor type

Models	Motor kW	W	(H)	(L)	a	b	c	(d)	(e)	f	g	h	A	B	Mass kg Less motor
MDE50-200	18.5	490	460	1232	440	230	740	1120	190	260	100	4 - \varnothing 23	50	80	350
	22			1262											385
	30			1300											405
	37	736	475	1358											670
MDE65-160	18.5	610	435	1347	550	230	840	1250	205	235	100	4 - \varnothing 23	65	100	360
	22		455	1377											375
	30	610	1415	415											
	37	736	475	1473											670

Note: The dimensions and mass may differ with the type of motor installed.

Flange mounted motor type

Models	Motor kW	W	H	(L)	a	b	c	(d)	(e)	f	g	h	A	B	Mass kg Less motor
MDE125-250 (4P)	11	610	645	994	550	280	740	1200	230	355	140	4 - \varnothing 27	125	150	350
	15			1038											355
	18.5/22			1063											410

Note: The dimensions and mass may differ with the type of motor installed. Please contact us for details of MDE50-200 and MDE65-160.

Iwaki process magnetic drive pump series

MDM SERIES

Magnetic drive process pumps with dry running capability

Specifications

- Max. discharge capacity: 1.4m³/min
- Max. head: 74m
- Main materials: CFRETFE/PFA
- Liquid temp. range: -20 to 105°C (CFRETFE), -20 to 150°C (PFA)

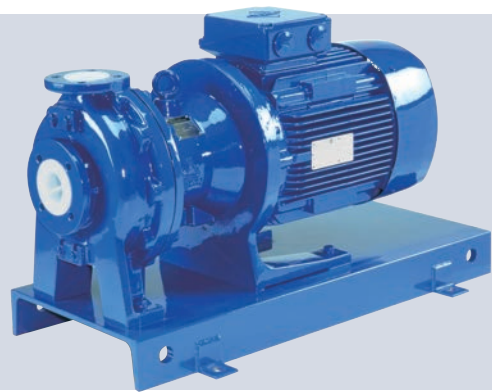

MXM SERIES

Magnetic drive pumps with an excellent balance of features and performance

Specifications

- Max. discharge capacity: 600l/min
- Max. head: 29m
- Main materials: CFRETFE
- Liquid temp. range: -10 to 105°C



MX SERIES

Withstands difficult operating conditions and offers high efficiency

Specifications

- Max. discharge capacity: 500l/min
- Max. head: 35m (MX), 30m (MX-F)
- Main materials: GFRPP (MX), CFRETFE (MX-F)
- Liquid temp. range: 0 to 80°C



SMX SERIES

Versatile self-priming magnetic drive pump with enhanced durability under abnormal operation

Specifications

- Max. discharge capacity: 345l/min
- Max. head: 18m
- Main materials: GFRPP (SMX), GFRPP (SMX-F)
- Liquid temp. range: 0 to 80°C



<https://www.iwaki.es>

IWAKI Europe Branch Spain, Carretera de l'Hospitalet, 147 3a B, 08940 Cornellà-Barcelona, Spain
 TEL: +34-934/741-638 FAX: +34-934/741-638 E-Mail: sales@iwaki.de

⚠ Caution for safety use:
 Before use of pump, read instruction manual carefully to use the product correctly.

Actual pumps may differ from the photos. Specifications and dimensions are subject to change without prior notice. For further details please contact us.

⚠ Legal attention related to export.

Our products and/or parts of products fall in the category of goods contained in control list of international regime for export control. Please be reminded that export license could be required when products are exported due to export control regulations of countries.

The posting and copying from this catalogue without permission is not accepted firmly.